

MALAX PNEUMATIC TOOLS PVT. LTD.

We Stand

“To Provide Quality & Economic Solutions to the Customer's Fastening requirements”

Malax Pneumatic Tools Pvt. Ltd. is involved in manufacturing of pneumatic tool accessories like impact sockets, impact extension sockets, impact extension bars, square drive adapters, hex adapters, stud tighteners, swivel sockets, swivel joints, universal joints, universal sockets, insert sockets, impact bit sockets/nut runners, quick change adapters etc.

We also undertake manufacturing of special pneumatic tool accessories as per customer drawings/specifications.

Malax pneumatic tool accessories are made from tested alloy steel, hardened & tempered to withstand the constant shocks transmitted from power drive tools (pneumatic/electric). Malax pneumatic tool accessories are supplied in industrial black finish. These accessories can also be used with torque wrenches and manual drivers.

The manufacturing plant is located in Noida (India), a distance of 25 kms from New Delhi. The plant has all the necessary infrastructure, machinery & skilled manpower for manufacturing quality products.

INDEX

TOOLS	SQ. DRIVE	SIZES	SERIES	PAGE NO.
Impact Sockets (Single & Double Hex)	1/4" - 2.1/2"	3.20 - 160 mm A/F	MIS/MGIS	1 - 12
Impact Extension Sockets	3/8" - 1/2"	8 - 24 mm A/F L : 100 - 250 mm	MGIES	12 - 13
Impact Extension Bars	1/4" - 2.1/2"	L : 55 - 600 mm	MIEB/MGIEB	13 - 16
Impact Square Drive Adapters	1/4" - 2.1/2"	3/8" - 2.1/2" (Male Sq.)	MIDA/MGIDA	16 - 17
Impact Hex Adapters	1/4" - 1"	2.5 - 36 mm (Hex A/F)	MGIHA	17 - 18
Impact Stud Tighteners	3/8" - 1"	M6 - M36 (Thread Size)	MGIST	18 - 20
Impact Swivel Sockets	3/8" - 1/2"	6 - 24 mm A/F	MGISS	20 - 21
Impact Swivel Joints	1/4" - 1"	1/4" - 1" (Male Sq.)	MISJ/MGISJ	21 - 22
Impact Universal Joints	1/4" - 1"	L : 40 - 158 mm	MIUJ/MGIUJ	22
Impact Universal Sockets	3/8" - 1/2"	8 - 80 mm A/F	MGIUS	22 - 23
Insert Sockets	24 - 100 mm (Female Hex)	24 - 100 mm (Male Hex)	MIIS	23
Impact Bit Sockets (Non Magnetic & Magnetic)	1/4" (Male Hex Dr.)	3.2 - 14 mm A/F L : 75 - 300 mm	MNR	24 - 25
Impact Magnetic Sockets	1/4" - 1/2"	7 - 17 mm A/F	MMGIS	25 - 26
Impact Quick Change Adapters	1/4" - 1/2"	6.35 (Hex A/F)	MQCA	26
Impact Hex-Sq. Adapters	6.35 (Male Hex A/F)	1/4" - 3/8" (Male Sq.)	MHSA	26
Flex Handles	1/4" - 1"	L : 145 - 700 mm	MFH	27
Sliding T-Handles	1/4" - 1"	L : 120 - 500	MST	27



Std. Length Impact Sockets with Cross Holes on Square Drive (MIS Series)

1/4" Sq. Drive

Stock No. (Single Hex)	Stock No. (Double Hex)	Hex Size A/F (mm)	O.A.L. (mm)
MIS 003.2	MIS 003.2B	3.2	25
MIS 004	MIS 004B	4	25
MIS 005	MIS 005B	5	25
MIS 006	MIS 006B	6	25
MIS 007	MIS 007B	7	25
MIS 008	MIS 008B	8	25
MIS 009	MIS 009B	9	25
MIS 010	MIS 010B	10	25
MIS 011	MIS 011B	11	25
MIS 012	MIS 012B	12	25
MIS 013	MIS 013B	13	25
MIS 014	MIS 014B	14	25



3/8" Sq. Drive

Stock No. (Single Hex)	Stock No. (Double Hex)	Hex Size A/F (mm)	O.A.L. (mm)
MIS 106	MIS 106B	6	30
MIS 107	MIS 107B	7	30
MIS 108	MIS 108B	8	30
MIS 109	MIS 109B	9	30
MIS 110	MIS 110B	10	30
MIS 111	MIS 111B	11	30
MIS 112	MIS 112B	12	30
MIS 113	MIS 113B	13	30
MIS 114	MIS 114B	14	30
MIS 115	MIS 115B	15	30
MIS 116	MIS 116B	16	30
MIS 117	MIS 117B	17	30
MIS 118	MIS 118B	18	30
MIS 119	MIS 119B	19	30
MIS 120	MIS 120B	20	30
MIS 121	MIS 121B	21	30
MIS 122	MIS 122B	22	30
MIS 123	MIS 123B	23	30
MIS 124	MIS 124B	24	30



Std. Length Impact Sockets with Cross Holes on Square Drive (MIS Series)

1/2" Sq. Drive



Stock No. (Single Hex)	Stock No. (Double Hex)	Hex Size A/F (mm)	O.A.L. (mm)
MIS 208	MIS 208B	8	40
MIS 209	MIS 209B	9	40
MIS 210	MIS 210B	10	40
MIS 211	MIS 211B	11	40
MIS 212	MIS 212B	12	40
MIS 213	MIS 213B	13	40
MIS 214	MIS 214B	14	40
MIS 215	MIS 215B	15	40
MIS 216	MIS 216B	16	40
MIS 217	MIS 217B	17	40
MIS 218	MIS 218B	18	40
MIS 219	MIS 219B	19	40
MIS 220	MIS 220B	20	40
MIS 221	MIS 221B	21	40
MIS 222	MIS 222B	22	40
MIS 223	MIS 223B	23	40
MIS 224	MIS 224B	24	40
MIS 225	MIS 225B	25	40
MIS 226	MIS 226B	26	40
MIS 227	MIS 227B	27	40
MIS 228	MIS 228B	28	40
MIS 229	MIS 229B	29	40
MIS 230	MIS 230B	30	42
MIS 231	MIS 231B	31	42
MIS 232	MIS 232B	32	44
MIS 233	MIS 233B	33	44
MIS 234	MIS 234B	34	45
MIS 235	MIS 235B	35	45
MIS 236	MIS 236B	36	45

3/4" Sq. Drive



Stock No. (Single Hex)	Stock No. (Double Hex)	Hex Size A/F (mm)	O.A.L. (mm)
MIS 317	MIS 317B	17	40
MIS 319	MIS 319B	19	40
MIS 322	MIS 322B	22	40
MIS 324	MIS 324B	24	40
MIS 327	MIS 327B	27	40
MIS 330	MIS 330B	30	45
MIS 332	MIS 332B	32	45
MIS 336	MIS 336B	36	45
MIS 338	MIS 338B	38	50
MIS 341	MIS 341B	41	50
MIS 346	MIS 346B	46	55
MIS 350	MIS 350B	50	55
MIS 355	MIS 355B	55	60
MIS 360	MIS 360B	60	60



Std. Length Impact Sockets with Cross Holes on Square Drive (MIS Series)

1" Sq. Drive

Stock No. (Single Hex)	Stock No. (Double Hex)	Hex Size A/F (mm)	O.A.L. (mm)
MIS 419	MIS 419B	19	45
MIS 422	MIS 422B	22	46
MIS 424	MIS 424B	24	48
MIS 427	MIS 427B	27	50
MIS 430	MIS 430B	30	52
MIS 432	MIS 432B	32	54
MIS 436	MIS 436B	36	56
MIS 438	MIS 438B	38	58
MIS 441	MIS 441B	41	60
MIS 446	MIS 446B	46	63
MIS 450	MIS 450B	50	65
MIS 455	MIS 455B	55	70
MIS 460	MIS 460B	60	72
MIS 465	MIS 465B	65	75
MIS 470	MIS 470B	70	78
MIS 475	MIS 475B	75	82
MIS 480	MIS 480B	80	87
MIS 485	MIS 485B	85	92
MIS 490	MIS 490B	90	97
MIS 495	MIS 495B	95	102
MIS 4100	MIS 4100B	100	107

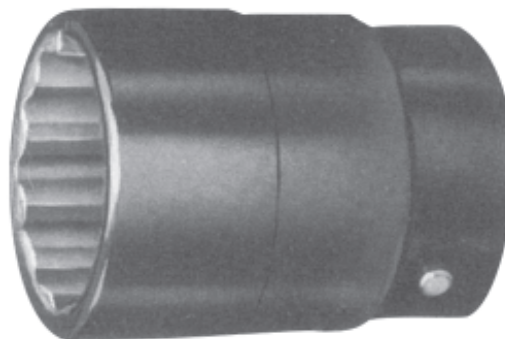

Deep Impact Sockets with Cross Holes on Square Drive (MIS Series)

1/4" Sq. Drive

Stock No. (Single Hex)	Stock No. (Double Hex)	Hex Size A/F (mm)	O.A.L. (mm)
MIS 003.2D	MIS 003.2BD	3.2	50
MIS 004D	MIS 004BD	4	50
MIS 005D	MIS 005BD	5	50
MIS 006D	MIS 006BD	6	50
MIS 007D	MIS 007BD	7	50
MIS 008D	MIS 008BD	8	50
MIS 009D	MIS 009BD	9	50
MIS 010D	MIS 010BD	10	50
MIS 011D	MIS 011BD	11	50
MIS 012D	MIS 012BD	12	50
MIS 013D	MIS 013BD	13	50
MIS 014D	MIS 014BD	14	50





Deep Impact Sockets with Cross Holes on Square Drive (MIS Series)

3/8" Sq. Drive

Stock No. (Single Hex)	Stock No. (Double Hex)	Hex Size A/F (mm)	O.A.L. (mm)
MIS 106D	MIS 106BD	6	60
MIS 107D	MIS 107BD	7	60
MIS 108D	MIS 108BD	8	60
MIS 109D	MIS 109BD	9	60
MIS 110D	MIS 110BD	10	60
MIS 111D	MIS 111BD	11	60
MIS 112D	MIS 112BD	12	60
MIS 113D	MIS 113BD	13	60
MIS 114D	MIS 114BD	14	60
MIS 115D	MIS 115BD	15	60
MIS 116D	MIS 116BD	16	60
MIS 117D	MIS 117BD	17	60
MIS 118D	MIS 118BD	18	60
MIS 119D	MIS 119BD	19	60
MIS 120D	MIS 120BD	20	60
MIS 121D	MIS 121BD	21	60
MIS 122D	MIS 122BD	22	60
MIS 123D	MIS 123BD	23	60
MIS 124D	MIS 124BD	24	60

1/2" Sq. Drive

Stock No. (Single Hex)	Stock No. (Double Hex)	Hex Size A/F (mm)	O.A.L. (mm)
MIS 208D	MIS 208BD	8	80
MIS 209D	MIS 209BD	9	80
MIS 210D	MIS 210BD	10	80
MIS 211D	MIS 211BD	11	80
MIS 212D	MIS 212BD	12	80
MIS 213D	MIS 213BD	13	80
MIS 214D	MIS 214BD	14	80
MIS 215D	MIS 215BD	15	80
MIS 216D	MIS 216BD	16	80
MIS 217D	MIS 217BD	17	80
MIS 218D	MIS 218BD	18	80
MIS 219D	MIS 219BD	19	80
MIS 220D	MIS 220BD	20	80
MIS 221D	MIS 221BD	21	80
MIS 222D	MIS 222BD	22	80
MIS 223D	MIS 223BD	23	80
MIS 224D	MIS 224BD	24	80
MIS 225D	MIS 225BD	25	80
MIS 226D	MIS 226BD	26	80
MIS 227D	MIS 227BD	27	80
MIS 228D	MIS 228BD	28	80
MIS 229D	MIS 229BD	29	80
MIS 230D	MIS 230BD	30	80
MIS 231D	MIS 231BD	31	80
MIS 232D	MIS 232BD	32	80
MIS 233D	MIS 233BD	33	80
MIS 234D	MIS 234BD	34	80
MIS 235D	MIS 235BD	35	80
MIS 236D	MIS 236BD	36	80



**Deep Impact Sockets with Cross Holes on Square Drive
(MIS Series)**

3/4" Sq. Drive

Stock No. (Single Hex)	Stock No. (Double Hex)	Hex Size A/F (mm)	O.A.L. (mm)
MIS 317D	MIS 317BD	17	80
MIS 319D	MIS 319BD	19	80
MIS 322D	MIS 322BD	22	80
MIS 324D	MIS 324BD	24	80
MIS 327D	MIS 327BD	27	80
MIS 330D	MIS 330BD	30	80
MIS 332D	MIS 332BD	32	85
MIS 336D	MIS 336BD	36	85
MIS 338D	MIS 338BD	38	90
MIS 341D	MIS 341BD	41	90
MIS 346D	MIS 346BD	46	90
MIS 350D	MIS 350BD	50	95
MIS 355D	MIS 355BD	55	100
MIS 360D	MIS 360BD	60	100



1" Sq. Drive

Stock No. (Single Hex)	Stock No. (Double Hex)	Hex Size A/F (mm)	O.A.L. (mm)
MIS 419D	MIS 419BD	19	80
MIS 422D	MIS 422BD	22	80
MIS 424D	MIS 424BD	24	80
MIS 427D	MIS 427BD	27	80
MIS 430D	MIS 430BD	30	85
MIS 432D	MIS 432BD	32	85
MIS 436D	MIS 436BD	36	90
MIS 438D	MIS 438BD	38	90
MIS 441D	MIS 441BD	41	90
MIS 446D	MIS 446BD	46	95
MIS 450D	MIS 450BD	50	95
MIS 455D	MIS 455BD	55	100
MIS 460D	MIS 460BD	60	105
MIS 465D	MIS 465BD	65	110
MIS 470D	MIS 470BD	70	115
MIS 475D	MIS 475BD	75	120
MIS 480D	MIS 480BD	80	125
MIS 485D	MIS 485BD	85	130
MIS 490D	MIS 490BD	90	135
MIS 495D	MIS 495BD	95	140
MIS 4100D	MIS 4100BD	100	150



Std. Length Impact Sockets with Cross Holes on Sq. Dr. for Locking Pin and 'O' Ring (MGIS Series)

1/4" Sq. Drive



Stock No. (Single Hex)	Stock No. (Double Hex)	Hex Size A/F (mm)	O.A.L. (mm)
MGIS 003.2	MGIS 003.2B	3.2	25
MGIS 004	MGIS 004B	4	25
MGIS 005	MGIS 005B	5	25
MGIS 006	MGIS 006B	6	25
MGIS 007	MGIS 007B	7	25
MGIS 008	MGIS 008B	8	25
MGIS 009	MGIS 009B	9	25
MGIS 010	MGIS 010B	10	25
MGIS 011	MGIS 011B	11	25
MGIS 012	MGIS 012B	12	25
MGIS 013	MGIS 013B	13	25
MGIS 014	MGIS 014B	14	25

3/8" Sq. Drive



Stock No. (Single Hex)	Stock No. (Double Hex)	Hex Size A/F (mm)	O.A.L. (mm)
MGIS 106	MGIS 106B	6	30
MGIS 107	MGIS 107B	7	30
MGIS 108	MGIS 108B	8	30
MGIS 109	MGIS 109B	9	30
MGIS 110	MGIS 110B	10	30
MGIS 111	MGIS 111B	11	30
MGIS 112	MGIS 112B	12	30
MGIS 113	MGIS 113B	13	30
MGIS 114	MGIS 114B	14	30
MGIS 115	MGIS 115B	15	30
MGIS 116	MGIS 116B	16	30
MGIS 117	MGIS 117B	17	30
MGIS 118	MGIS 118B	18	30
MGIS 119	MGIS 119B	19	30
MGIS 120	MGIS 120B	20	30
MGIS 121	MGIS 121B	21	30
MGIS 122	MGIS 122B	22	30
MGIS 123	MGIS 123B	23	30
MGIS 124	MGIS 124B	24	30



Std. Length Impact Sockets with Cross Holes on Sq. Dr. for Locking Pin and 'O' Ring (MGIS Series)

1/2" Sq. Drive

Stock No. (Single Hex)	Stock No. (Double Hex)	Hex Size A/F (mm)	O.A.L. (mm)
MGIS 208	MGIS 208B	8	40
MGIS 209	MGIS 209B	9	40
MGIS 210	MGIS 210B	10	40
MGIS 211	MGIS 211B	11	40
MGIS 212	MGIS 212B	12	40
MGIS 213	MGIS 213B	13	40
MGIS 214	MGIS 214B	14	40
MGIS 215	MGIS 215B	15	40
MGIS 216	MGIS 216B	16	40
MGIS 217	MGIS 217B	17	40
MGIS 218	MGIS 218B	18	40
MGIS 219	MGIS 219B	19	40
MGIS 220	MGIS 220B	20	40
MGIS 221	MGIS 221B	21	40
MGIS 222	MGIS 222B	22	40
MGIS 223	MGIS 223B	23	40
MGIS 224	MGIS 224B	24	40
MGIS 225	MGIS 225B	25	40
MGIS 226	MGIS 226B	26	40
MGIS 227	MGIS 227B	27	40
MGIS 228	MGIS 228B	28	40
MGIS 229	MGIS 229B	29	40
MGIS 230	MGIS 230B	30	42
MGIS 231	MGIS 231B	31	42
MGIS 232	MGIS 232B	32	44
MGIS 233	MGIS 233B	33	44
MGIS 234	MGIS 234B	34	45
MGIS 235	MGIS 235B	35	45
MGIS 236	MGIS 236B	36	45

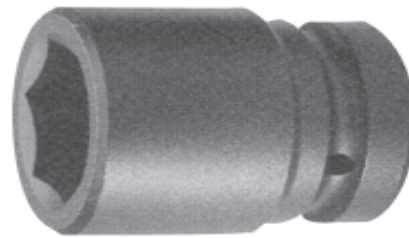

3/4" Sq. Drive

Stock No. (Single Hex)	Stock No. (Double Hex)	Hex Size A/F (mm)	O.A.L. (mm)
MGIS 317	MGIS 317B	17	40
MGIS 319	MGIS 319B	19	40
MGIS 322	MGIS 322B	22	40
MGIS 324	MGIS 324B	24	40
MGIS 327	MGIS 327B	27	40
MGIS 330	MGIS 330B	30	45
MGIS 332	MGIS 332B	32	45
MGIS 336	MGIS 336B	36	45
MGIS 338	MGIS 338B	38	50
MGIS 341	MGIS 341B	41	50
MGIS 346	MGIS 346B	46	55
MGIS 350	MGIS 350B	50	55
MGIS 355	MGIS 355B	55	60
MGIS 360	MGIS 360B	60	60

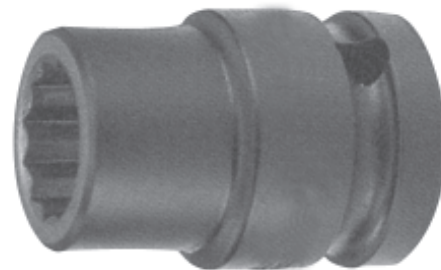

Std. Length Impact Sockets with Cross Holes on Sq. Dr. for Locking Pin and 'O' Ring (MGIS Series)



1" Sq. Drive

Stock No. (Single Hex)	Stock No. (Double Hex)	Hex Size A/F (mm)	O.A.L. (mm)
MGIS 419	MGIS 419B	19	45
MGIS 422	MGIS 422B	22	46
MGIS 424	MGIS 424B	24	48
MGIS 427	MGIS 427B	27	50
MGIS 430	MGIS 430B	30	52
MGIS 432	MGIS 432B	32	54
MGIS 436	MGIS 436B	36	56
MGIS 438	MGIS 438B	38	58
MGIS 441	MGIS 441B	41	60
MGIS 446	MGIS 446B	46	63
MGIS 450	MGIS 450B	50	65
MGIS 455	MGIS 455B	55	70
MGIS 460	MGIS 460B	60	72
MGIS 465	MGIS 465B	65	75
MGIS 470	MGIS 470B	70	78
MGIS 475	MGIS 475B	75	82
MGIS 480	MGIS 480B	80	87
MGIS 485	MGIS 485B	85	92
MGIS 490	MGIS 490B	90	97
MGIS 495	MGIS 495B	95	102
MGIS 4100	MGIS 4100B	100	107

1 1/2" Sq. Drive

Stock No. (Single Hex)	Stock No. (Double Hex)	Hex Size A/F (mm)	O.A.L. (mm)
MGIS 536	MGIS 536B	36	70
MGIS 538	MGIS 538B	38	70
MGIS 541	MGIS 541B	41	75
MGIS 546	MGIS 546B	46	75
MGIS 550	MGIS 550B	50	80
MGIS 555	MGIS 555B	55	80
MGIS 560	MGIS 560B	60	84
MGIS 565	MGIS 565B	65	84
MGIS 570	MGIS 570B	70	90
MGIS 575	MGIS 575B	75	90
MGIS 580	MGIS 580B	80	95
MGIS 585	MGIS 585B	85	100
MGIS 590	MGIS 590B	90	105
MGIS 595	MGIS 595B	95	110
MGIS 5100	MGIS 5100B	100	115
MGIS 5105	MGIS 5105B	105	120
MGIS 5110	MGIS 5110B	110	125
MGIS 5115	MGIS 5115B	115	130
MGIS 5120	MGIS 5120B	120	135



Single Hex Impact Sockets with Cross Holes on Sq. Dr. for Locking Pin and 'O' Ring (MGIS Series)

2 1/2" Sq. Drive

Stock No. (Single Hex)	Hex Size A/F (mm)	O.A.L. (mm)
MGIS 660	60	140
MGIS 665	65	140
MGIS 670	70	145
MGIS 675	75	145
MGIS 680	80	145
MGIS 685	85	145
MGIS 690	90	160
MGIS 695	95	160
MGIS 6100	100	160
MGIS 6105	105	160
MGIS 6110	110	170
MGIS 6115	115	170
MGIS 6120	120	170
MGIS 6125	125	180
MGIS 6130	130	190
MGIS 6135	135	190
MGIS 6140	140	195
MGIS 6145	145	195
MGIS 6150	150	200
MGIS 6155	155	200
MGIS 6160	160	200



Deep Impact Sockets with Cross Holes on Sq. Dr. for Locking Pin & 'O' Ring (MGIS Series)

1/4" Sq. Drive

Stock No. (Single Hex)	Stock No. (Double Hex)	Hex Size A/F (mm)	O.A.L. (mm)
MGIS 003.2D	MGIS 003.2BD	3.2	50
MGIS 004D	MGIS 004BD	4	50
MGIS 005D	MGIS 005BD	5	50
MGIS 006D	MGIS 006BD	6	50
MGIS 007D	MGIS 007BD	7	50
MGIS 008D	MGIS 008BD	8	50
MGIS 009D	MGIS 009BD	9	50
MGIS 010D	MGIS 010BD	10	50
MGIS 011D	MGIS 011BD	11	50
MGIS 012D	MGIS 012BD	12	50
MGIS 013D	MGIS 013BD	13	50
MGIS 014D	MGIS 014BD	14	50





Deep Impact Sockets with Cross Holes on Sq. Dr. for Locking Pin & 'O' Ring (MGIS Series)

3/8" Sq. Drive

Stock No. (Single Hex)	Stock No. (Double Hex)	Hex Size A/F (mm)	O.A.L. (mm)
MGIS 106D	MGIS 106BD	6	60
MGIS 107D	MGIS 107BD	7	60
MGIS 108D	MGIS 108BD	8	60
MGIS 109D	MGIS 109BD	9	60
MGIS 110D	MGIS 110BD	10	60
MGIS 111D	MGIS 111BD	11	60
MGIS 112D	MGIS 112BD	12	60
MGIS 113D	MGIS 113BD	13	60
MGIS 114D	MGIS 114BD	14	60
MGIS 115D	MGIS 115BD	15	60
MGIS 116D	MGIS 116BD	16	60
MGIS 117D	MGIS 117BD	17	60
MGIS 118D	MGIS 118BD	18	60
MGIS 119D	MGIS 119BD	19	60
MGIS 120D	MGIS 120BD	20	60
MGIS 121D	MGIS 121BD	21	60
MGIS 122D	MGIS 122BD	22	60
MGIS 123D	MGIS 123BD	23	60
MGIS 124D	MGIS 124BD	24	60

1/2" Sq. Drive

Stock No. (Single Hex)	Stock No. (Double Hex)	Hex Size A/F (mm)	O.A.L. (mm)
MGIS 208D	MGIS 208BD	8	80
MGIS 209D	MGIS 209BD	9	80
MGIS 210D	MGIS 210BD	10	80
MGIS 211D	MGIS 211BD	11	80
MGIS 212D	MGIS 212BD	12	80
MGIS 213D	MGIS 213BD	13	80
MGIS 214D	MGIS 214BD	14	80
MGIS 215D	MGIS 215BD	15	80
MGIS 216D	MGIS 216BD	16	80
MGIS 217D	MGIS 217BD	17	80
MGIS 218D	MGIS 218BD	18	80
MGIS 219D	MGIS 219BD	19	80
MGIS 220D	MGIS 220BD	20	80
MGIS 221D	MGIS 221BD	21	80
MGIS 222D	MGIS 222BD	22	80
MGIS 223D	MGIS 223BD	23	80
MGIS 224D	MGIS 224BD	24	80
MGIS 225D	MGIS 225BD	25	80
MGIS 226D	MGIS 226BD	26	80
MGIS 227D	MGIS 227BD	27	80
MGIS 228D	MGIS 228BD	28	80
MGIS 229D	MGIS 229BD	29	80
MGIS 230D	MGIS 230BD	30	80
MGIS 231D	MGIS 231BD	31	80
MGIS 232D	MGIS 232BD	32	80
MGIS 233D	MGIS 233BD	33	80
MGIS 234D	MGIS 234BD	34	80
MGIS 235D	MGIS 235BD	35	80
MGIS 236D	MGIS 236BD	36	80



Deep Impact Sockets with Cross Holes on Sq. Dr. for Locking Pin & 'O' Ring (MGIS Series)

3/4" Sq. Drive

Stock No. (Single Hex)	Stock No. (Double Hex)	Hex Size A/F (mm)	O.A.L. (mm)
MGIS 317D	MGIS 317BD	17	80
MGIS 319D	MGIS 319BD	19	80
MGIS 322D	MGIS 322BD	22	80
MGIS 324D	MGIS 324BD	24	80
MGIS 327D	MGIS 327BD	27	80
MGIS 330D	MGIS 330BD	30	80
MGIS 332D	MGIS 332BD	32	85
MGIS 336D	MGIS 336BD	36	85
MGIS 338D	MGIS 338BD	38	90
MGIS 341D	MGIS 341BD	41	90
MGIS 346D	MGIS 346BD	46	90
MGIS 350D	MGIS 350BD	50	95
MGIS 355D	MGIS 355BD	55	100
MGIS 360D	MGIS 360BD	60	100

1" Sq. Drive

Stock No. (Single Hex)	Stock No. (Double Hex)	Hex Size A/F (mm)	O.A.L. (mm)
MGIS 419D	MGIS 419BD	19	80
MGIS 422D	MGIS 422BD	22	80
MGIS 424D	MGIS 424BD	24	80
MGIS 427D	MGIS 427BD	27	80
MGIS 430D	MGIS 430BD	30	85
MGIS 432D	MGIS 432BD	32	85
MGIS 436D	MGIS 436BD	36	90
MGIS 438D	MGIS 438BD	38	90
MGIS 441D	MGIS 441BD	41	90
MGIS 446D	MGIS 446BD	46	95
MGIS 450D	MGIS 450BD	50	95
MGIS 455D	MGIS 455BD	55	100
MGIS 460D	MGIS 460BD	60	105
MGIS 465D	MGIS 465BD	65	110
MGIS 470D	MGIS 470BD	70	115
MGIS 475D	MGIS 475BD	75	120
MGIS 480D	MGIS 480BD	80	125
MGIS 485D	MGIS 485BD	85	130
MGIS 490D	MGIS 490BD	90	135
MGIS 495D	MGIS 495BD	95	140
MGIS 4100D	MGIS 4100BD	100	150





Deep Impact Sockets with Cross Holes on Sq. Dr. for Locking Pin & 'O' Ring (MGIS Series)

1 1/2" Sq. Drive

Stock No. (Single Hex)	Stock No. (Double Hex)	Hex Size A/F (mm)	O.A.L. (mm)
MGIS 536D	MGIS 536BD	36	105
MGIS 538D	MGIS 538BD	38	105
MGIS 541D	MGIS 541BD	41	105
MGIS 546D	MGIS 546BD	46	115
MGIS 550D	MGIS 550BD	50	115
MGIS 555D	MGIS 555BD	55	130
MGIS 560D	MGIS 560BD	60	130
MGIS 565D	MGIS 565BD	65	135
MGIS 570D	MGIS 570BD	70	140
MGIS 575D	MGIS 575BD	75	145
MGIS 580D	MGIS 580BD	80	150
MGIS 585D	MGIS 585BD	85	155
MGIS 590D	MGIS 590BD	90	160
MGIS 595D	MGIS 595BD	95	170
MGIS 5100D	MGIS 5100BD	100	180
MGIS 5105D	MGIS 5105BD	105	190
MGIS 5110D	MGIS 5110BD	110	195
MGIS 5115D	MGIS 5115BD	115	195
MGIS 5120D	MGIS 5120BD	120	200

Single Hex Impact Extension Sockets with Cross Holes on Sq. Dr. for Locking Pin and 'O' Ring (MGIES Series)



3/8" Sq. Drive

Stock No.	A/F (mm)	Bolt Clearance Depth (mm)	O.A.L. (mm)
MGIES 108S	8	14	100
MGIES 108L	8	14	150
MGIES 108X	8	14	200
MGIES 108XL	8	14	250
MGIES 110S	10	16	100
MGIES 110L	10	16	150
MGIES 110X	10	16	200
MGIES 110XL	10	16	250
MGIES 112S	12	18	100
MGIES 112L	12	18	150
MGIES 112X	12	18	200
MGIES 112XL	12	18	250
MGIES 114S	14	20	100
MGIES 114L	14	20	150
MGIES 114X	14	20	200
MGIES 114XL	14	20	250



Single Hex Impact Extension Sockets with Cross Holes on Sq. Dr. for Locking Pin and 'O' Ring (MGIES Series)



1/2" Sq. Drive

Stock No.	A/F (mm)	Bolt Clearance Depth (mm)	O.A.L. (mm)
MGIES 210S	10	16	100
MGIES 210L	10	16	150
MGIES 210X	10	16	200
MGIES 210XL	10	16	250
MGIES 212S	12	18	100
MGIES 212L	12	18	150
MGIES 212X	12	18	200
MGIES 212XL	12	18	250
MGIES 214S	14	20	100
MGIES 214L	14	20	150
MGIES 214X	14	20	200
MGIES 214XL	14	20	250
MGIES 217S	17	22	100
MGIES 217L	17	22	150
MGIES 217X	17	22	200
MGIES 217LX	17	22	250
MGIES 219S	19	24	100
MGIES 219L	19	24	150
MGIES 219X	19	24	200
MGIES 219XL	19	24	250
MGIES 222S	22	25	100
MGIES 222L	22	25	150
MGIES 222X	22	25	200
MGIES 222XL	22	25	250
MGIES 224S	24	25	100
MGIES 224X	24	25	150
MGIES 224L	24	25	200
MGIES 224XL	24	25	250

Impact Extension Bars with Cross Holes on Sq. Drive & Locking Ball on Male Sq. (MIEB Series)



1/4" Sq. Drive

Stock No.	O.A.L. (mm)
MIEB 055	55
MIEB 0100	100
MIEB 0150	150

Impact Extension Bars with Cross Holes on Sq. Drive & Locking Ball on Male Sq. (MIEB Series)



3/8" Sq. Drive

Stock No.	O.A.L. (mm)
MIEB 175	75
MIEB 1100	100
MIEB 1125	125
MIEB 1150	150
MIEB 1200	200
MIEB 1300	300
MIEB 1400	400



1/2" Sq. Drive

Stock No.	O.A.L. (mm)
MIEB 275	75
MIEB 2100	100
MIEB 2125	125
MIEB 2150	150
MIEB 2210	210
MIEB 2250	250
MIEB 2300	300
MIEB 2400	400
MIEB 2500	500
MIEB 2600	600



3/4" Sq. Drive

Stock No.	O.A.L. (mm)
MIEB 3210	210
MIEB 3430	430



1" Sq. Drive

Stock No.	O.A.L. (mm)
MIEB 4200	200
MIEB 4400	400

Impact Extension Bars with Locking Pin & 'O' Ring on Sq. Drive & Cross Holes on Male Sq. (MGIEB Series)

1/4" Sq. Drive

Stock No.	O.A.L. (mm)
MGIEB 055	55
MGIEB 0100	100
MGIEB 0150	150



3/8" Sq. Drive

Stock No.	O.A.L. (mm)
MGIEB 175	75
MGIEB 1100	100
MGIEB 1125	125
MGIEB 1150	150
MGIEB 1200	200
MGIEB 1250	250
MGIEB 1300	300
MGIEB 1400	400



1/2" Sq. Drive

Stock No.	O.A.L. (mm)
MGIEB 275	75
MGIEB 2100	100
MGIEB 2125	125
MGIEB 2150	150
MGIEB 2210	210
MGIEB 2250	250
MGIEB 2300	300
MGIEB 2400	400
MGIEB 2500	500
MGIEB 2600	600



3/4" Sq. Drive

Stock No.	O.A.L. (mm)
MGIEB 3210	210
MGIEB 3430	430



Impact Extension Bars with Locking Pin & 'O' Ring on Sq. Drive & Cross Holes on Male Sq. (MGIEB Series)

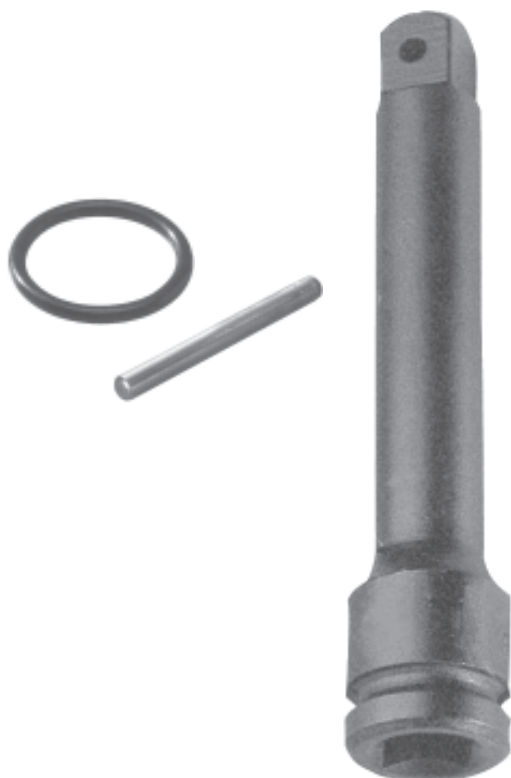

1" Sq. Drive

Stock No.	O.A.L. (mm)
MGIEB 4200	210
MGIEB 4400	400

1½" Sq. Drive

Stock No.	O.A.L. (mm)
MGIEB 5250	250
MGIEB 5500	500

2½" Sq. Drive

Stock No.	O.A.L. (mm)
MGIEB 6250	250
MGIEB 6380	380
MGIEB 6510	510

Sq. Dr. Adapters with Cross holes on Female Sq. Drive & Locking Ball on Male Sq. (MIDA Series)

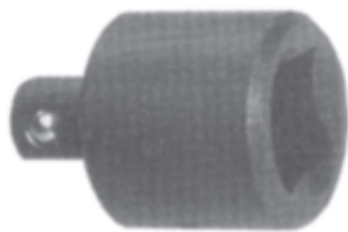

	Female Sq.	Male Sq.	O.A.L. (mm)
MIDA 01	1/4"	3/8"	25
MIDA 10	3/8"	1/4"	30
MIDA 12	3/8"	1/2"	35
MIDA 21	1/2"	3/8"	37
MIDA 23	1/2"	3/4"	44
MIDA 32	3/4"	1/2"	55
MIDA 34	3/4"	1"	65
MIDA 43	1"	3/4"	70
MIDA 45	1"	1½"	90
MIDA 54	1½"	1"	110
MIDA 56	1½"	2½"	135
MIDA 65	2½"	1½"	165

Sq. Dr. Adapters with Locking Pin & 'O' Ring on Sq. Dr. & Cross Holes on Male Sq. (MGIDA Series)

	Female Sq.	Male Sq.	O.A.L. (mm)
MGIDA 01	1/4"	3/8"	25
MGIDA 10	3/8"	1/4"	30
MGIDA 12	3/8"	1/2"	35
MGIDA 21	1/2"	3/8"	37
MGIDA 23	1/2"	3/4"	44
MGIDA 32	3/4"	1/2"	55
MGIDA 34	3/4"	1"	65
MGIDA 43	1"	3/4"	70
MGIDA 45	1"	1.1/2"	90
MGIDA 54	1.1/2"	1"	110
MGIDA 56	1.1/2"	2.1/2"	135
MGIDA 65	2.1/2"	1.1/2"	165



Impact Hex Adapters with Locking Pin & 'O' Ring on Sq. Dr. (MGIHA Series)

1/4" Sq. Drive

Stock No.	Hex Size A/F (mm)	Hex Length (mm)	O.A.L. (mm)
MGIHA 002.5	2.5	15	35
MGIHA 003	3	15	35
MGIHA 004	4	20	40
MGIHA 005	5	20	40
MGIHA 006	6	25	45



3/8" Sq. Dr.

Stock No.	Hex Size A/F (mm)	Hex Length (mm)	O.A.L. (mm)
MGIHA 103	3	15	40
MGIHA 104	4	15	40
MGIHA 105	5	20	45
MGIHA 106	6	25	50
MGIHA 108	8	25	50
MGIHA 110	10	25	50

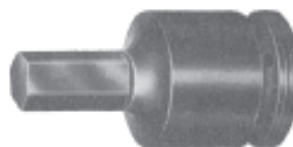

1/2" Sq. Dr.

Stock No.	Hex Size A/F (mm)	Hex Length (mm)	O.A.L. (mm)
MGIHA 206	6	20	50
MGIHA 208	8	25	50
MGIHA 210	10	25	55
MGIHA 212	12	30	60
MGIHA 214	14	30	60
MGIHA 217	17	30	60

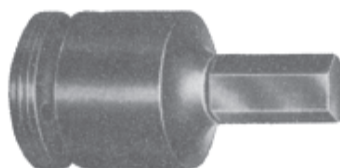



Impact Hex Adapters with Locking Pin & 'O' Ring on Sq. Dr. (MGIHA Series)

3/4" Sq. Dr.

Stock No.	Hex Size A/F (mm)	Hex Length (mm)	O.A.L. (mm)
MGIHA 312	12	30	80
MGIHA 314	14	30	80
MGIHA 317	17	30	80
MGIHA 319	19	30	80
MGIHA 322	22	35	85
MGIHA 324	24	35	85

1" Sq. Dr.

Stock No.	Hex Size A/F (mm)	Hex Length (mm)	O.A.L. (mm)
MGIHA 417	17	30	75
MGIHA 419	19	30	75
MGIHA 422	22	35	80
MGIHA 424	24	35	80
MGIHA 427	27	40	85
MGIHA 432	32	40	85
MGIHA 436	36	40	85

Impact Stud Tighteners with Locking Pin & 'O' Ring (MGIST Series)

3/8" Sq. Dr.



Stock No.	Thread Size	Pitch (mm)	O.A.L. (mm)
MGIST 106	M6	1.00	30
MGIST 106/0.75	M6	0.75	30
MGIST 107	M7	1.00	30
MGIST 107/0.75	M7	0.75	30
MGIST 108	M8	1.25	30
MGIST 108/1	M8	1.00	30
MGIST 110	M10	1.50	30
MGIST 110/1	M10	1.00	30
MGIST 110/1.25	M10	1.25	30
MGIST 206	M6	1.00	40
MGIST 206/0.75	M6	0.75	40
MGIST 207	M7	1.00	40
MGIST 207/0.75	M7	0.75	40

Impact Stud Tighteners with Locking Pin & 'O' Ring(MGIST Series)

1/2" Sq. Dr.

Stock No.	Thread Size	Pitch (mm)	O.A.L. (mm)
MGIST 208	M8	1.25	40
MGIST 208/1	M8	1.00	40
MGIST 210	M10	1.50	40
MGIST 210/1	M10	1.00	40
MGIST 210/1.25	M10	1.25	40
MGIST 212	M12	1.75	40
MGIST 212/1.25	M12	1.25	40
MGIST 212/1.5	M12	1.50	40
MGIST 214	M14	2.00	40
MGIST 214/1.25	M14	1.25	40
MGIST 214/1.5	M14	1.50	40
MGIST 216	M16	2.00	40
MGIST 216/1.5	M16	1.50	40

3/4" Sq. Dr.

Stock No.	Thread Size	Pitch (mm)	O.A.L. (mm)
MGIST 316	M16	2.00	47
MGIST 316/1.5	M16	1.50	47
MGIST 318	M18	2.50	47
MGIST 318/1.5	M18	1.50	47
MGIST 320	M20	2.50	50
MGIST 320/1.5	M20	1.50	50
MGIST 320/2	M20	2.00	50
MGIST 322	M22	2.50	50
MGIST 322/1.5	M22	1.50	50
MGIST 322/2	M22	2.00	50
MGIST 324	M24	3.00	50
MGIST 324/1.5	M24	1.50	50
MGIST 324/2	M24	2.00	50





**Ring
(MGIST Series)**

1" Sq. Dr.

Stock No.	Thread Size	Pitch (mm)	O.A.L. (mm)
MGIST 424	M24	3.00	65
MGIST 424/1.5	M24	1.50	65
MGIST 424/2	M24	2.00	65
MGIST 427	M27	3.00	65
MGIST 427/1.5	M27	1.50	65
MGIST 427/2	M27	2.00	65
MGIST 430	M30	3.50	70
MGIST 430/1.5	M30	1.50	70
MGIST 430/2	M30	2.00	70
MGIST 430/3	M30	3.00	70
MGIST 433	M33	3.50	70
MGIST 433/1.5	M33	1.50	70
MGIST 433/2	M33	2.00	70
MGIST 433/3	M33	3.00	70
MGIST 436	M36	4.00	75
MGIST 436/1.5	M36	1.50	75
MGIST 436/2	M36	2.00	75
MGIST 436/3	M36	3.00	75



**Impact Swivel Sockets with Cross Holes on Sq. Dr.
for Locking Pin & 'O' Ring.
(MGISS Series)**

3/8" Sq. Dr.

Stock No.	A/F (mm)	O.A.L. (mm)
MGISS 108	8	55
MGISS 110	10	55
MGISS 112	12	60
MGISS 114	14	60

1/2" Sq. Dr.

Stock No.	A/F (mm)	O.A.L. (mm)
MGISS 210	10	60
MGISS 212	12	70
MGISS 214	14	70
MGISS 217	17	70
MGISS 219	19	70
MGISS 222	22	75
MGISS 224	24	75



Impact Swivel Extension Sockets with Cross Holes on Sq. Dr. for Locking Pin & 'O' Ring (MGISES Series)

3/8" Sq. Dr.

Stock No.	A/F (mm)	O.A.L. (mm)
MGISES 108S	8	100
MGISES 108L	8	150
MGISES 108X	8	200
MGISES 110S	10	100
MGISES 110L	10	150
MGISES 110X	10	200
MGISES 112S	12	100
MGISES 112L	12	150
MGISES 112X	12	200
MGISES 114S	14	100
MGISES 114L	14	150
MGISES 114X	14	200

1/2" Sq. Dr.

Stock No.	A/F (mm)	O.A.L. (mm)
MGISES 210S	10	100
MGISES 210L	10	150
MGISES 210X	10	200
MGISES 212S	12	100
MGISES 212L	12	150
MGISES 212X	12	200
MGISES 214S	14	100
MGISES 214L	14	150
MGISES 214X	14	200
MGISES 217S	17	100
MGISES 217L	17	150
MGISES 217X	17	200
MGISES 219S	19	100
MGISES 219L	19	150
MGISES 219X	19	200
MGISES 222S	22	100
MGISES 222L	22	150
MGISES 222X	22	200
MGISES 224S	24	100
MGISES 224L	24	150
MGISES 224X	24	200



Impact Swivel Joints with Cross Holes on Sq. Dr. & Locking Ball on Male Sq. (MISJ Series)

Stock No.	Sq. Dr.	Male Sq.	O.A.L. (mm)
MISJ 06	1/4"	1/4"	45
MISJ 10	3/8"	3/8"	53
MISJ 12	1/2"	1/2"	65
MISJ 20	3/4"	3/4"	80
MISJ 25	1"	1"	100

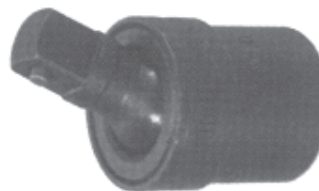

MALAX PNEUMATIC TOOLS PVT. LTD.



Impact Swivel Joints with Cross Holes on Sq. Dr. for Locking Pin & 'O' Ring and Cross Holes on Male Sq. (MGISJ Series)

Stock No.	Sq. Dr.	Male Sq.	O.A.L. (mm)
MGISJ 06	1/4"	1/4"	45
MGISJ 10	3/8"	3/8"	53
MGISJ 12	1/2"	1/2"	65
MGISJ 20	3/4"	3/4"	80
MGISJ 25	1"	1"	100

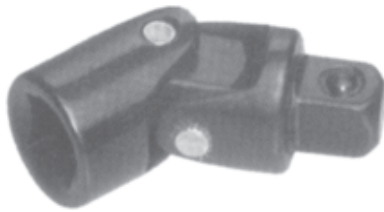

Impact Universal Joints with Cross Holes on Sq. Dr. and Locking Ball on Male Sq. (MIUJ Series)

Stock No.	Sq. Dr.	O.A.L. (mm)
MIUJ 06	1/4"	40
MIUJ 10	3/8"	50
MIUJ 12	1/2"	75
MIUJ 20	3/4"	110
MIUJ 25	1"	158



Impact Universal Joints with Cross Holes on Sq. Dr. for Locking Pin & 'O' Ring and Cross on Male Square. (MGIUJ Series)

Stock No.	Sq. Dr.	O.A.L. (mm)
MGIUJ 06	1/4"	40
MGIUJ 10	3/8"	50
MGIUJ 12	3/4"	75
MGIUJ 20	1/2"	110
MGIUJ 25	1"	158



Impact Universal Sockets with Cross Holes on Sq. Dr. for Locking Pin & 'O' Ring. (MGIUS Series)

3/8" Sq. Dr.

Stock No.	A/F (mm)	O.A.L. (mm)
MGIUS 108	8	50
MGIUS 110	10	53
MGIUS 112	12	55
MGIUS 114	14	55



Impact Universal Sockets with Cross Holes on Sq. Dr. for Locking Pin & 'O' Ring. (MGIUS Series)



1/2" Sq. Dr.

Stock No.	A/F (mm)	O.A.L. (mm)
MGIUS 210	10	75
MGIUS 212	12	75
MGIUS 214	14	80
MGIUS 217	17	80
MGIUS 219	19	80

Insert Sockets (MIIS Series)

Stock No.	Female Hex Size (mm)	Male Hex Size (mm)	O.A.L. (mm)
MIIS 24	24	24	65
MIIS 27	27	27	65
MIIS 30	30	30	70
MIIS 36	36	36	75
MIIS 38	38	38	75
MIIS 41	41	41	85
MIIS 46	46	46	90
MIIS 50	50	50	95
MIIS 55	55	55	95
MIIS 60	60	60	105
MIIS 65	65	65	110
MIIS 70	70	70	120
MIIS 75	75	75	125
MIIS 80	80	80	135
MIIS 85	85	85	140
MIIS 90	90	90	145
MIIS 95	95	95	150
MIIS 100	100	100	155





1/4" Male Hex Drive Impact Bit Sockets / Nut Runners. (MNR Series)

Stock No.	Hex A/F (mm)	O.A.L. (mm)
MNR 003.2	3.2	75
MNR 003.2 S	3.2	100
MNR 003.2 L	3.2	150
MNR 004	4	75
MNR 004 S	4	100
MNR 004 L	4	150
MNR 005	5	75
MNR 005 S	5	100
MNR 005 L	5	150
MNR 005.5	5.5	75
MNR 005.5 S	5.5	100
MNR 005.5 L	5.5	150
MNR 006	6	75
MNR 006 S	6	100
MNR 006 L	6	150
MNR 007	7	75
MNR 007 S	7	100
MNR 007 L	7	150
MNR 007 X	7	200
MNR 007 XL	7	250
MNR 007 XXL	7	300
MNR 008	8	75
MNR 008 S	8	100
MNR 008 L	8	150
MNR 008 X	8	200
MNR 008 XL	8	250
MNR 008 XXL	8	300
MNR 010	10	75
MNR 010 S	10	100
MNR 010 L	10	150
MNR 010 X	10	200
MNR 010 XL	10	250
MNR 010 XXL	10	300
MNR 011	11	75
MNR 011 S	11	100
MNR 011 L	11	150
MNR 011 X	11	200
MNR 011 XL	11	250
MNR 011 XXL	11	300
MNR 012	12	75
MNR 012 S	12	100
MNR 012 L	12	150
MNR 012 X	12	200
MNR 012 XL	12	250
MNR 012 XXL	12	300
MNR 013	13	75
MNR 013 S	13	100
MNR 013 L	13	150
MNR 013 X	13	200
MNR 013 XL	13	250
MNR 013 XXL	13	300
MNR 014	14	75
MNR 014 S	14	100
MNR 014 L	14	150



1/4" Male Hex Drive Magnetic Impact Bit Sockets / Nut Runners (MMNR Series)

Stock No.	Hex A/F (mm)	O.A.L. (mm)
MMNR 007	7	75
MMNR 007 S	7	100
MMNR 007 L	7	150
MMNR 007 X	7	200
MMNR 007 XL	7	250
MMNR 007 XXL	7	300
MMNR 008	8	75
MMNR 008 S	8	100
MMNR 008 L	8	150
MMNR 008 X	8	200
MMNR 008 XL	8	250
MMNR 008 XXL	8	300
MMNR 010	10	75
MMNR 010 S	10	100
MMNR 010 L	10	150
MMNR 010 X	10	200
MMNR 010 XL	10	250
MMNR 010 XXL	10	300
MMNR 011	11	75
MMNR 011 S	11	100
MMNR 011 L	11	150
MMNR 011 X	11	200
MMNR 011 XL	11	250
MMNR 011 XXL	11	300
MMNR 012	12	75
MMNR 012 S	12	100
MMNR 012 L	12	150
MMNR 012 X	12	200
MMNR 012 XL	12	250
MMNR 012 XXL	12	300
MMNR 013	13	75
MMNR 013 S	13	100
MMNR 013 L	13	150
MMNR 013 X	13	200
MMNR 013 XL	13	250
MMNR 013 XXL	13	300
MMNR 014	14	75
MMNR 014 S	14	100
MMNR 014 L	14	150



Single Hex Magnetic Impact Sockets with Locking Pin & 'O' Ring (MMGIS Series)

1/4" Sq. Drive

Stock No.	Hex-size A/F (mm)	O.A.L. (mm)
MMGIS 007	7	25
MMGIS 008	8	25
MMGIS 009	9	25
MMGIS 010	10	25





**Single Hex Magnetic Impact Sockets
with Locking Pin & 'O' Ring
(MMGIS Series)**

3/8" Sq. Drive

Stock No.	Hex-size A/F (mm)	O.A.L. (mm)
MMGIS 108	8	30
MMGIS 109	9	30
MMGIS 110	10	30
MMGIS 111	11	30
MMGIS 112	12	30
MMGIS 113	13	30
MMGIS 114	14	30

1/2" Sq. Drive

Stock No.	Hex-size A/F (mm)	O.A.L. (mm)
MMGIS 210	10	40
MMGIS 211	11	40
MMGIS 212	12	40
MMGIS 213	13	40
MMGIS 214	14	40
MMGIS 215	15	40
MMGIS 216	16	40
MMGIS 217	17	40



**Impact Quick Change Adapters
(MQCA Series)**

Stock No.	Sq. drive	hex size A/F (mm)	O.A.L. (mm)
MQCA 00	1/4"	6.35	40
MQCA 10	3/8"	6.35	45
MQCA 20	1/2"	6.35	50



**Impact Hex-Square Adapters
(MHSA Series)**

Stock No.	Male hex A/F (mm)	Male Sq.	O.A.L. (mm)
MHSA 00	6.35	1/4"	50
MHSA 00 S	6.35	1/4"	100
MHSA 01	6.35	3/8"	50
MHSA 01 S	6.35	3/8"	100



**Flex Handles
(MFH Series)**

Stock No.	Sq. Size	O.A.L. (mm)
MFH 0145	1/4"	145
MFH 1200	3/8"	200
MFH 2260	1/2"	260
MFH 3500	3/4"	500
MFH 4700	1"	700



**Sliding T-handles
(MST Series)**

Stock No.	Sq. Size	O.A.L. (mm)
MST 0120	1/4"	120
MST 1230	3/8"	230
MST 2280	1/2"	280
MST 3450	3/4"	450
MST 4500	1"	500



Impact Sockets for Castle Nuts – As Per Customer Drawings.

